



NAWRAS

Nawras LTD

info@nawrasinchina.com

+86 19817999292

Inspection Report

(1ST 2ND)

PENDING

Pre-shipment ON-LINE IN PROCESS FULL

Summary Section

Service Number: F-QC 2503201420338038



ProductName	Chair&Table
Itemnumber	---
P/Onumber	---
Quantity	6pcs
Clientname	---
Suppliername	---
Inspectiondate	2025-3-21
Arrivaltime	9.30AM
Departuretime	15:00PM
Inspectionlocation	FoshanGuangdongChina
Inspector	Jackzhu

Category	Con form		Comment
1. Quantity	<input checked="" type="checkbox"/> YES	<input type="checkbox"/> NO	
2. Product description / style / color	<input checked="" type="checkbox"/> YES	<input type="checkbox"/> NO	
3. Workmanship	<input checked="" type="checkbox"/> YES	<input type="checkbox"/> NO	
4. Testing/ checking	<input type="checkbox"/> YES	<input checked="" type="checkbox"/> NO	Special attention 1 2
5. Data measurement	<input checked="" type="checkbox"/> YES	<input type="checkbox"/> NO	
6. Packaging	<input type="checkbox"/> YES	<input checked="" type="checkbox"/> NO	Special attention 3
7. marking	<input checked="" type="checkbox"/> YES	<input type="checkbox"/> NO	

OVERALL CONCLUSION	P ENDING
	Pending client review and approval

Special Attention	
--------------------------	--



NAWRAS

Nawras LTD

info@nawrasinchina.com

+86 19817999292

1. The marble table cannot be weighed.

2. The actual size of some parts of the chair is not consistent with the drawing. Please refer to the following drawings for details

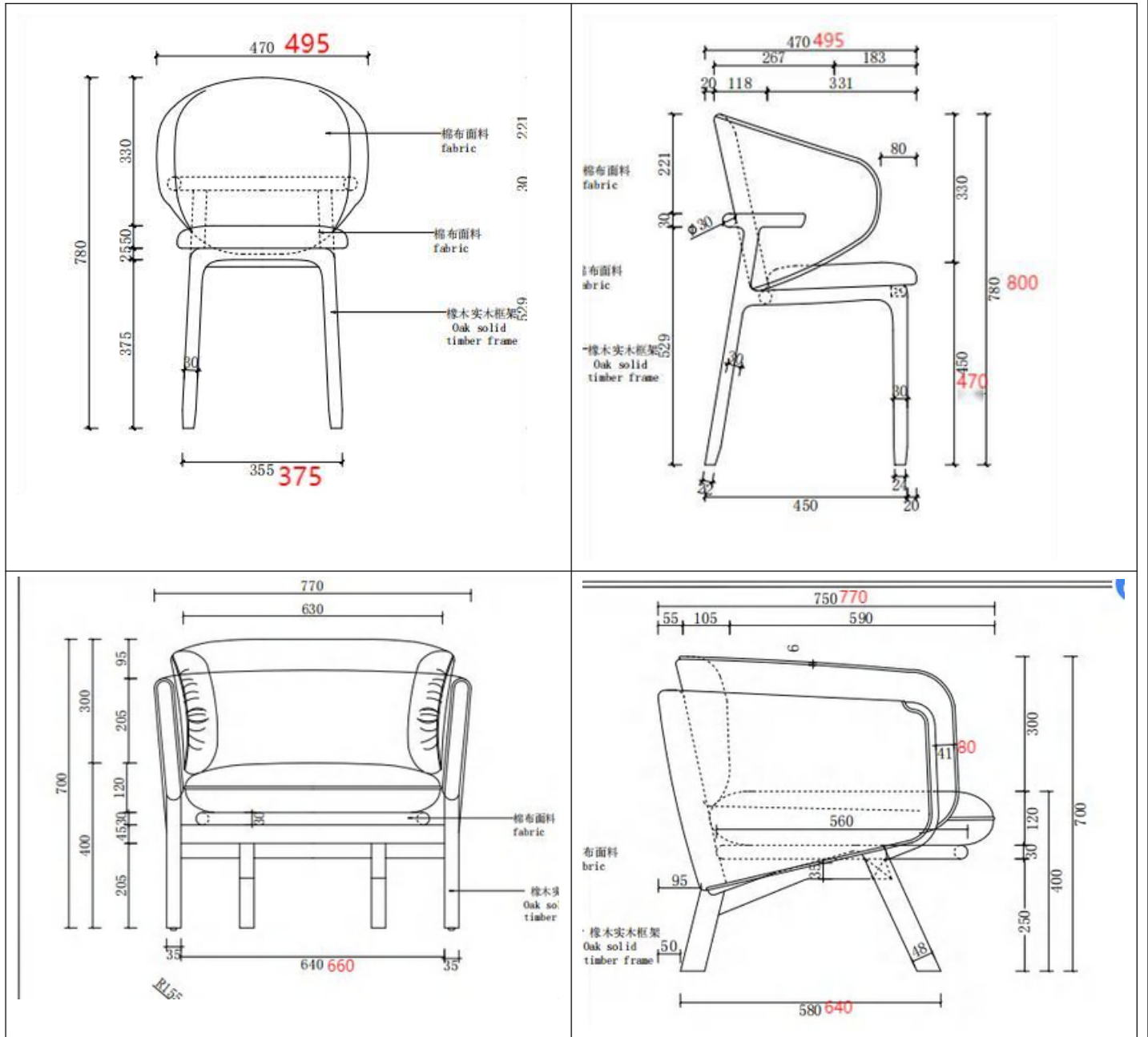

3. All products are without packaging.

Defective products

pick out

replace

rework

DETAILS
Quantity

Item	Ordered quantity	Total carton	Packed Quantity	Finished quantity	Not finished quantity	Sample Qty.	DEFECTS			Comment
							Cri	Maj	Min	
the inspection quantity for each item is according to the inspection level II						AQL	0.0	2.5	4.0	
						Ac	/	/	/	
Total	6	0	0	6	0	6	0	1	7	
Custom Arm chair	1	0	0	1	0	1	0	0	1	
Custom Side Table	1	0	0	1	0	1	0	0	0	
Custom Coffee Table	1	0	0	1	0	1	0	1	4	
Custom Side Table 1	1	0	0	1	0	1	0	0	1	
Chair	1	0	0	1	0	1	0		1	
Leisure chair	1	0	0	1	0	1	0	0	0	

Inspection Standard: ANSI/ASQZ1.4 (MIL-STD-105E)			DEFECTS		
Inspection Level: sample size has been determined			Critical	Major	Minor
Sampling plan: Single, Normal		AQL	0.0	2.5	4.0
Ordered Qty	SampleSize:	Max.Allowed:	/	/	/
6	6	DefectsFound:	0	1	7

Defects Found				
Defectives Description		CRI	MAJ	MIN
Chair				
1.	Thread end	0	0	1
Custom Armchair				
2.	Bump against	0	0	1
Custom Side Table 1				
3.	Scratch	0	0	1
Custom Side Table				
4.	Worn	0	1	0
5.	Fade	0	0	4









NAWRAS

Nawras LTD

info@nawrasinchina.com

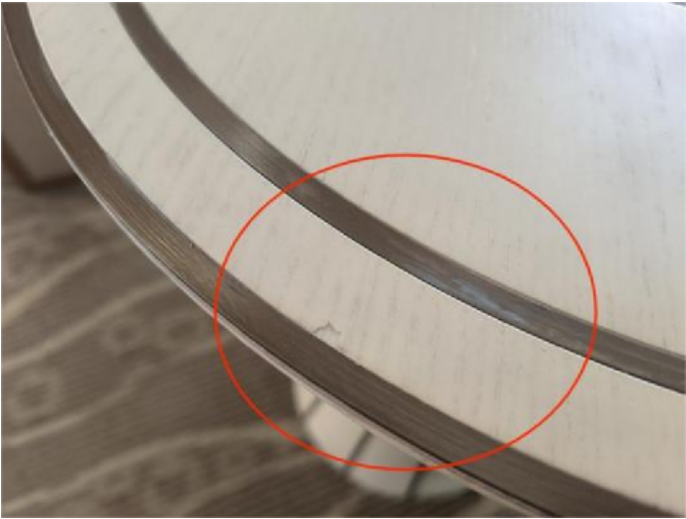
+86 19817999292

Defectives PIC	
Chair	
	N/A
Thread end-Min	N/A
Custom Armchair	
	N/A
Bump against-Min	N/A
Custom Side Tabl 1	
	N/A

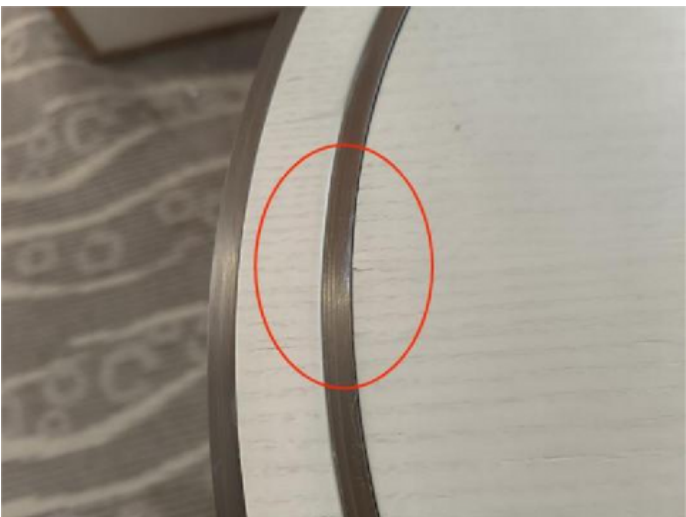
Scratch-Min	N/A
Custom Side Table	
	
Worn-Maj	Fade-Min
	
Fade-Min	Fade-Min
	N/A
Fade-Min	N/A



NAWRAS

Nawras LTD

info@nawrasinchina.com

+86 19817999292

TESTING /CHECKING&Data measurement

Inspection Standard: ANSI/ASQZ1.4 (MIL-STD-105E)				DEFE CT S			
Sampling plan: Single, Normal				AQL	0	0.65	1.5
InspectionLevel:	S-2	SampleSize:	5	Max. Allowed:	0	0	0

TESTING/CHECKING							
NO	testitem	Insp Level	Sample	CRI	MAJ	MIN	Conclusion
1.	Functiontest	---	6	0	0	0	Pass
2.	Rubtest	---	6	0	0	0	Pass
3.	Stabilitytest	---	6	0	0	0	Pass

Item Chair	Contract requirements	Measured data
Product size	N/A	49.5x49.5x80cm
Product weight	N/A	7.20kg
Item Custom Coffee Table	Contract requirements	Measured data
Product size	N/A	80x80x40.5cm
Product weight	N/A	9.30kg
Item Custon Armchair	Contract requirements	Measured data
Product size	N/A	81x88x76cm
Product weight	N/A	28.60kg
Item Custon Side Tabl 1	Contract requirements	Measured data
Product size	N/A	54.6x55cm
Product weight	N/A	N/A
Item Custon Side Table	Contract requirements	Measured data
Product size	N/A	45x55cm
Product weight	N/A	13.30kg
Item Leisure chair	Contract requirements	Measured data
Product size	N/A	77x79x70cm
Product weight	N/A	18.60kg



NAWRAS

Nawras LTD

info@nawrasinchina.com

+86 19817999292

[Product description / style / color](#)

Product description

Chair



1 Product view



2 Product view



3 Product view



4 Product view



5 Product view



6 Product view



7 Product view



8 Product view



9 Product view



10 Product view



11 Product view

12 Product view



13 Product view



14 Product view



15 Product view



16 Product view



17 Product view



18 Product view



19 Product view



20 Product view



21 Product view



22 Product view



23 Product view



24 Product view



25 Product view



26 Product view



27 Product weight



28 Product weight



29 Product size



30 Product size



31 Product size



32 Product size



33 Product size



34 Product size



35 Product size



36 Product size



37 Product size



38 Product size



39 Product size



40 Product size



41 Product size



42 Product size



43 Product size



44 Product size



45 Product size



46 Product size



47 Product size



48 Product size



49 Product size



50 Product size



51 Product size



52 Stability test



53 Stability test



54 Function test



55 Function test



56 Rub test



57 Rub test



58 Rub test

Custom Coffee Table



1 Product view



2 Product view



3 Product view

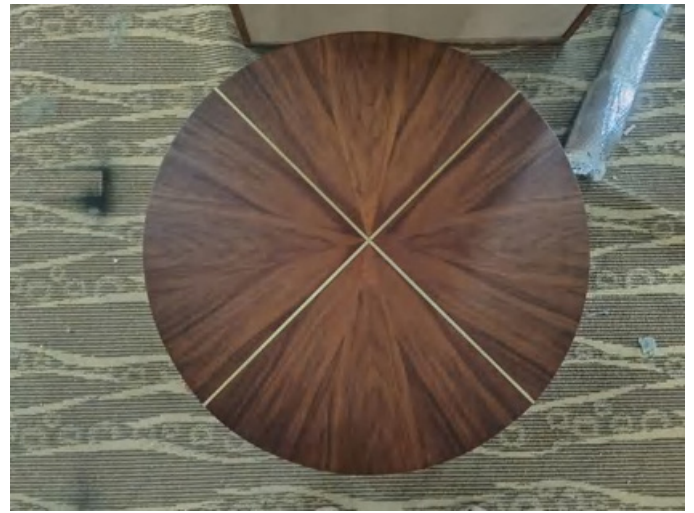

4 Product view



5 Product view



6 Product view



7 Product view

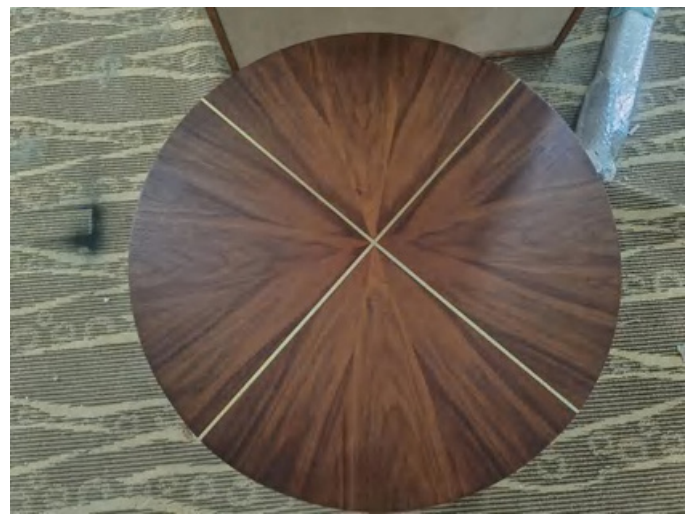

8 Product view



9 Product view



10 Product view



11 Product view



12 Product view



13 Product view



14 Product view



15 Product view



16 Product view



17 Product view



18 Product view

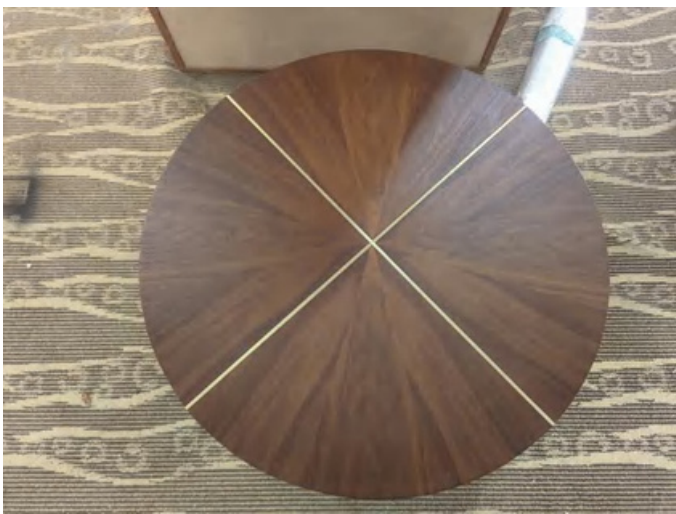

19 Product view



20 Product view



21 Product view

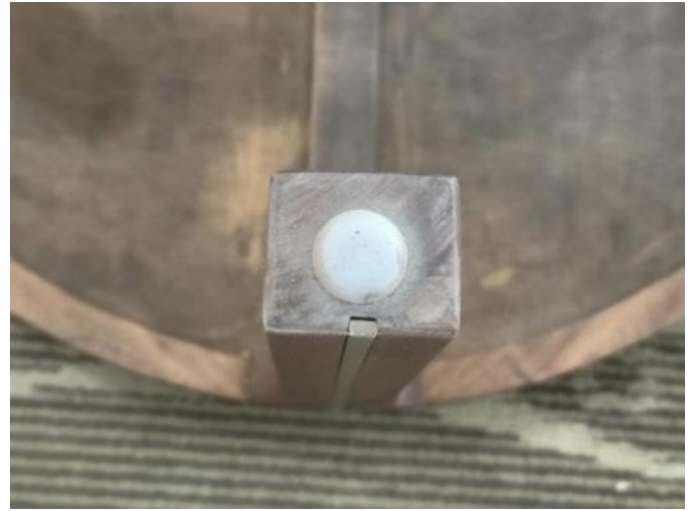

22 Product view



23 Product weight



24 Product weight



25 Product size



26 Product size



27 Product size



28 Product size



29 Product size



30 Product size



31 Product size



32 Product size



33 Stability test



34 Stability test

Custom Armchair



1 Product view



2 Product view



3 Product view



4 Product view



5 Product view

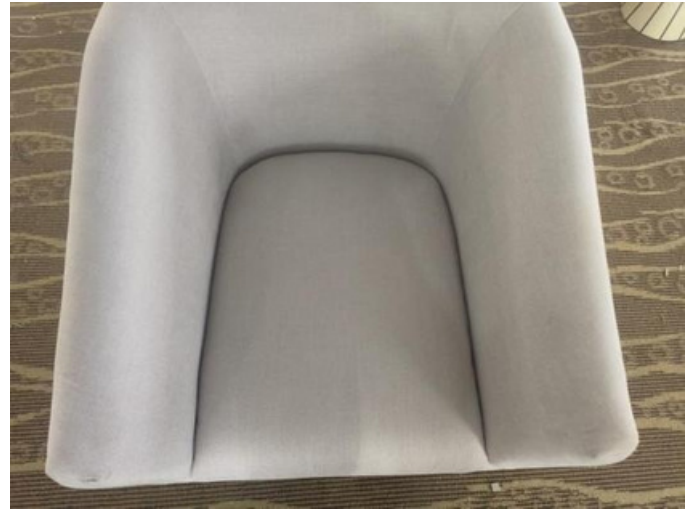

6 Product view



7 Product view



8 Product view



9 Product view



10 Product view



11 Product view



12 Product view



13 Product view



14 Product view



15 Product view



16 Product view



17 Product view



18 Product view



19 Product view



20 Product view



21 Product view



22 Product view



23 Product view



24 Product view



25 Product view



26 Product view



27 Product view



28 Product view



29 Product view



30 Product view



31 Product weight



32 Product weight



33 Product size



34 Product size



35 Product size



36 Product size



37 Product size



38 Product size



39 Product size



40 Product size



41 Product size



42 Product size



43 Product size









44 Product size



45 Product size



46 Product size

	
<p>47 Product size</p>	<p>48 Product size</p>
	
<p>49 Product size</p>	<p>50 Product size</p>
	
<p>51 Function test</p>	<p>52 Function test</p>
<p>Custom Side Tabl 1</p>	



1 Product view

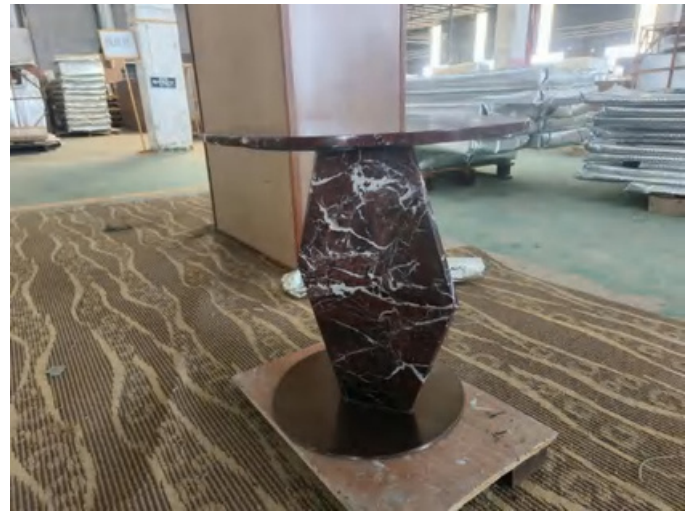

2 Product view



3 Product view



4 Product view



5 Product view



6 Product view



7 Product view



8 Product view



9 Product view



10 Product view



11 Product view



12 Product view



13 Product view



14 Product view



15 Product view



16 Product view



17 Product view



18 Product view



19 Product view



20 Product view



21 Product view



22 Product view



23 Product view



24 Product view



25 Product view



26 Product view



27 Product view



28 Product view



29 Product view



30 Product view



31 Product view



32 Product view



33 Product view



34 Product view



35 Product view

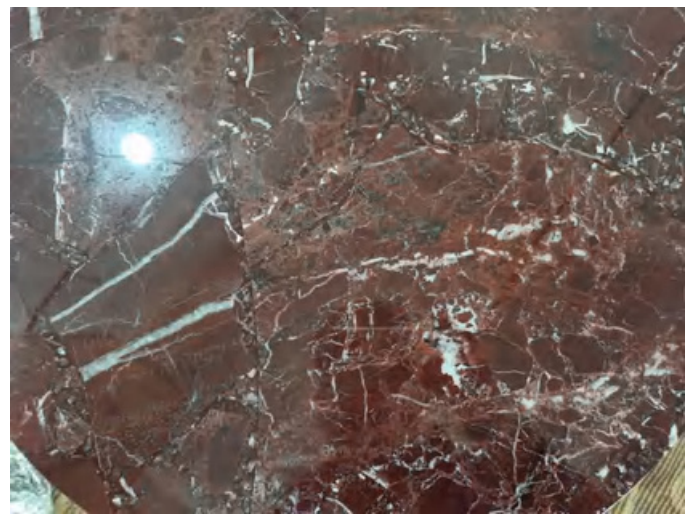

36 Product view



37 Product view



38 Product size



39 Product size



40 Product size



41 Product size



42 Product size

Custom Side Table



1 Product view



2 Product view

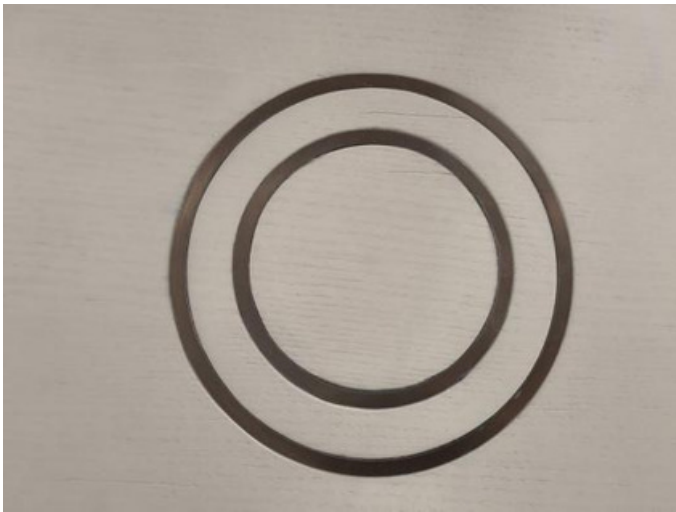

3 Product view



4 Product view



5 Product view



6 Product view

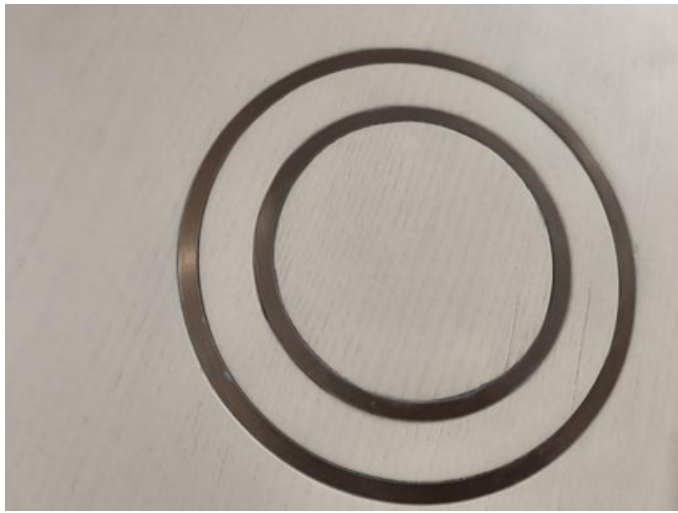

7 Product view



8 Product view



9 Product view



10 Product view



11 Product view



12 Product view



13 Product view



14 Product view



15 Product view



16 Product view



17 Product view



18 Product view



19 Product view



20 Product view



21 Product view



22 Product view



23 Product view



24 Product view



25 Product size



26 Product size



27 Product size



28 Product size



29 Product size



30 Product size



31 Product size



32 Product size



33 Product size



34 Product size

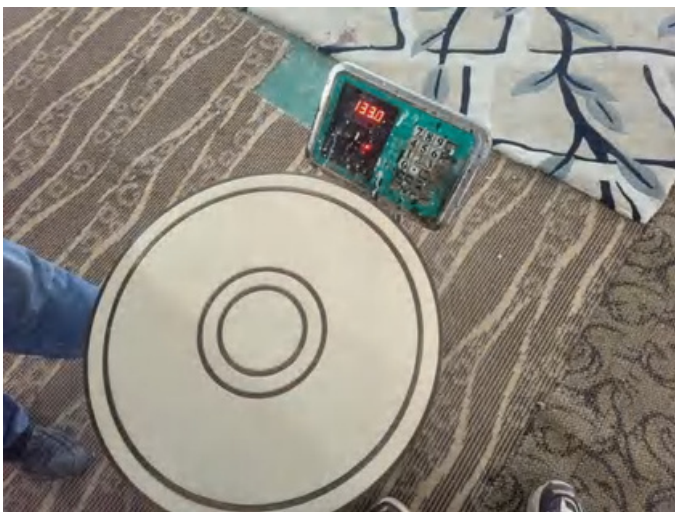

35 Product weight



36 Product weight

Leisure chair



1 Product view



2 Product view



3 Product view



4 Product view



5 Product view



6 Product view



7 Product view



8 Product view



9 Product view



10 Product view



11 Product view



12 Product view



13 Product view



14 Product view



15 Product view



16 Product view



17 Product view



18 Product view



19 Product view



20 Product view



21 Product view



22 Product view



23 Product view



24 Product view



25 Product view



26 Product view



27 Product view



28 Product view



29 Product view



30 Product view



31 Product view



32 Product view



33 Product view



34 Product view



35 Product view



36 Product view



37 Product weight



38 Product weight



39 Product size



40 Product size



41 Product size



42 Product size



43 Product size



44 Product size



45 Product size



46 Product size



47 Product size



48 Product size



49 Product size



50 Product size



51 Product size



52 Product size



53 Product size



54 Product size



55 Product size



56 Product size



57 Product size



58 Product size



59 Product size



60 Product size



61 Product size



62 Product size



63 Product size



64 Product size



65 Function test



66 Function test

	
<p>67 Stability test</p>	<p>68 Stability test</p>
	
<p>69 Rub test</p>	<p>70 Rub test</p>

<p>Cartons</p>	
	<p>N/A</p>
<p>Cargo pile</p>	<p>N/A</p>

INSEPCION SPOT



Factory gate



Factory gate

Note: This report reflects our findings at time and place of inspection.

This report does not relieve suppliers from their contractual liabilities or prejudice buyers' right for compensation for any apparent and/or hidden defects not detected during our random inspection or occurring thereafter.

-----END OF REPORT-----